

LAKE LIFTER

DC POWERED BOAT LIFT MOTORS

Instructions Wiring & System Diagrams



ELECTRONIC BRAKING NOTICE

Compatibility Issue



NEPTUNE BRAND G6 SUPER FAST LIFT (GEARBOX ISSUE)

Neptune Boat Lifts

4-Post Lifts

Flat Plate Drive

Direct Drive

G3 High Speed

G6 SuperFast

4,500 lbs.

7,000 lbs.

10,000 lbs.

13,000 lbs.

16,000 lbs.

20,000 lbs.

24,000 lbs.

30,000 lbs.



NOTE: Our DC-SOLAR motors will increase the normal lifting speed of any lift. Example: Our DC-SOLAR motor will increase the G3 lifting speed to near G6 lifting speeds.

Gearbox Ratio is too low and does NOT SELF LOCK: Boat will slowly lower on its own. Requires Electronic braking AC-motors only: Does Not work with DC-SOLAR SYSTEM



IMPORTANT: BATTERIES ARE THE LAST CONNECTIONS MADE!

Signal wires will be LIVE if batteries are connected and will likely result in a short connection when you are working with and routing signal wires to the master control box.

Keep batteries disconnected while installing the system, running wires & connections.

DUAL MOTOR (LEFT / RIGHT) System

Model: 2M-L/R



IMPORTANT: Boat Weight Distribution

The weight of your boat **MUST BE EVENLY DISTRIBUTED ON THE BEAMS** to ensure your safety and longevity of your lift. Consult the boat manufacturer for lifting points and center of gravity on your boat. Inspect lifting cables for damage and make sure that they are spooled properly to prevent shock or impact loads from damaging your boat or lift. This could result in structural or mechanical damage to your lift or boat as well as cause personal injury or death.

IMPORTANT: with DC-Motors it is critically important to keep the boat weight centered from left to right:

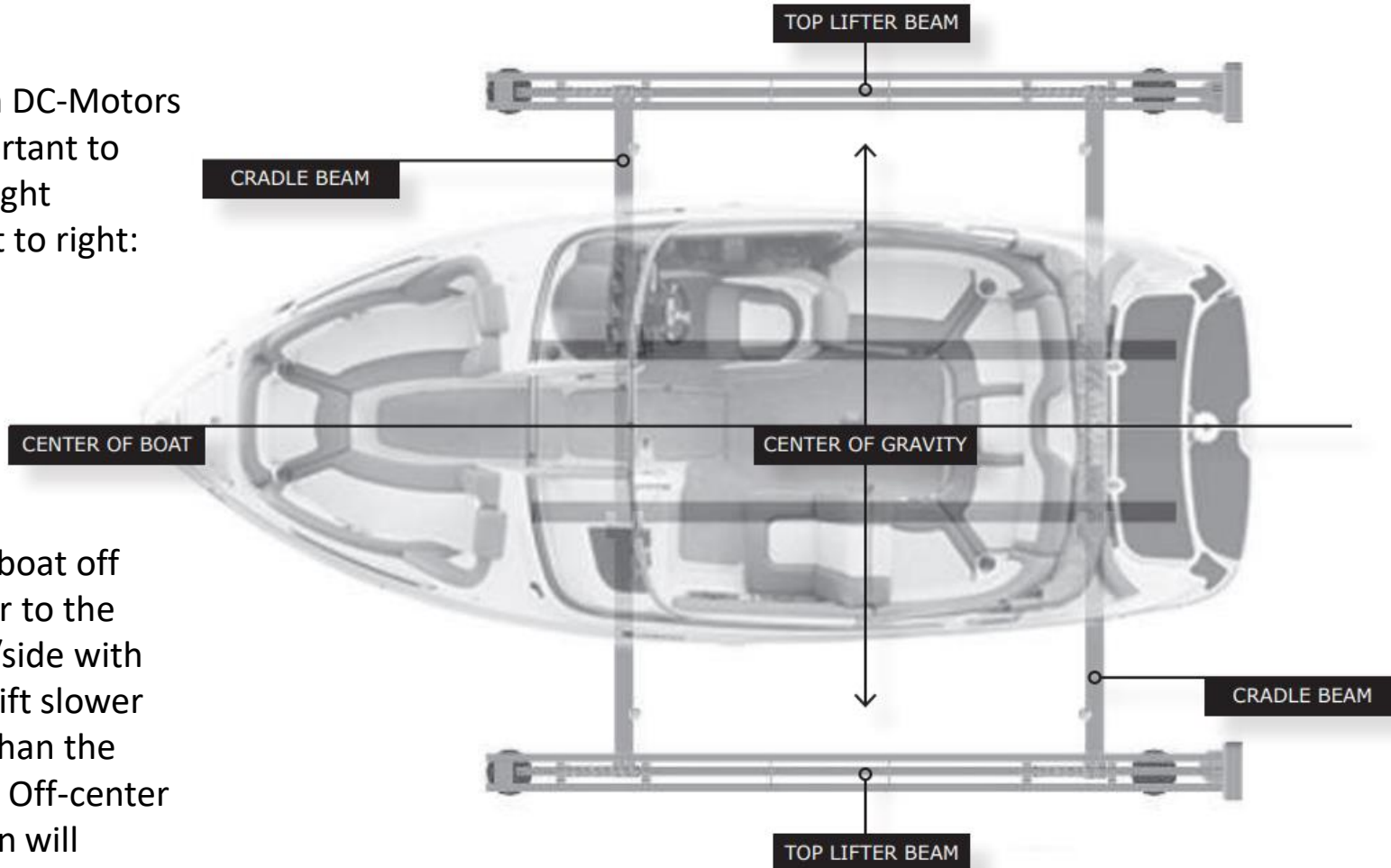

DO NOT shift the boat off center to be closer to the dock. The Motor/side with more weight will lift slower and lower faster than the other motor/side. Off-center weight distribution will require frequent leveling.

IMPORTANT: Electrical Connections

Electrical grease will protect and prolong electrical connections.

- Use dielectric grease to fill each motor and battery connector before connecting.
- Use dielectric grease on battery terminals.



IMPORTANT: Greasing Motor/Gearbox

EPOXY MOTOR

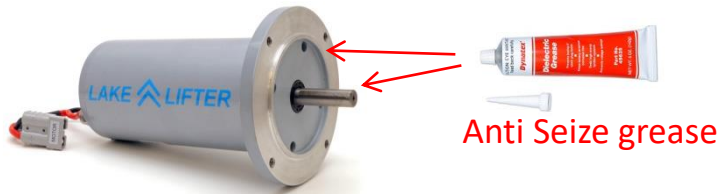

Anti Seize grease

Install the motor on the boat hoist gear box: Gearbox style & type vary based on brand. The Lake Lifter motor is a 56C frame style which fits all boat lift enclosed style Gearboxes.

IMPORTANT: use grease on the motor face and shaft before installing. This will make future removal easier if necessary.

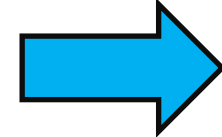
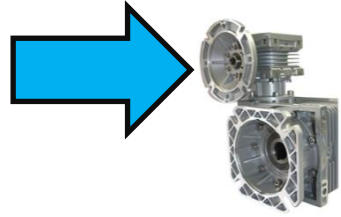

Example Installations

IMPORTANT: Stainless Steel motors REQUIRE a gasket between the motor and the gearbox. This will prevent dissimilar metal contact. Use anti seize grease on shaft.

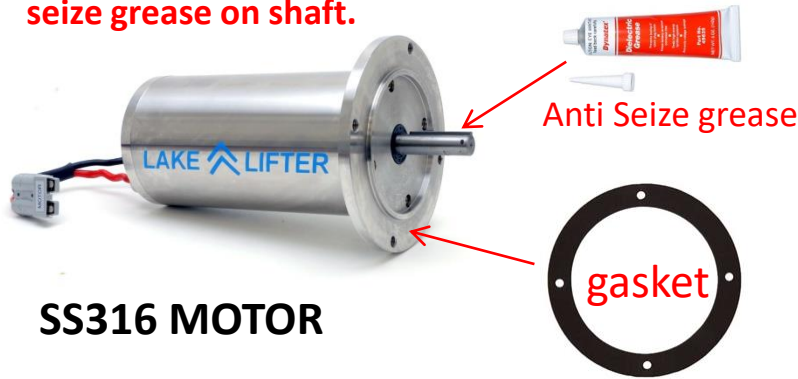

gasket

SS316 MOTOR

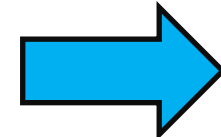
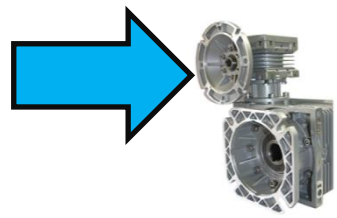

IMPORTANT: Greasing Motor/Gearbox

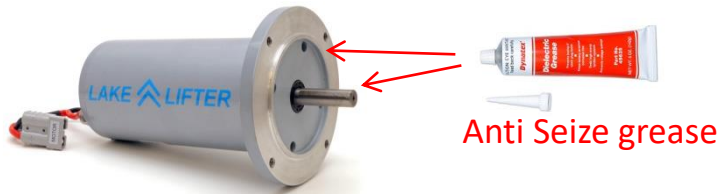

Install the motor on the boat hoist gear box: Gearbox style & type vary based on brand. The Lake Lifter motor is a 56C frame style which fits all boat lift enclosed style Gearboxes.

IMPORTANT: use grease on the motor face and shaft before installing. This will make future removal easier if necessary.

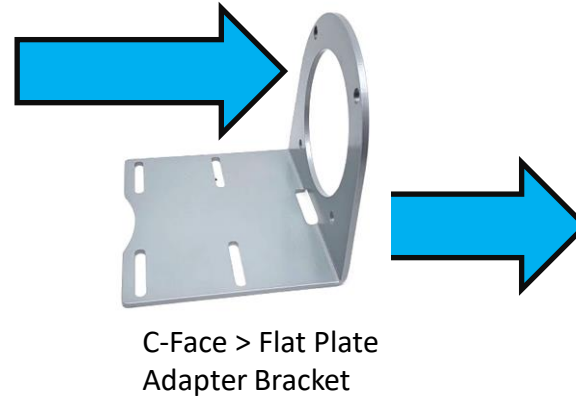

Example Installations

IMPORTANT: Stainless Steel motors REQUIRE a gasket between the motor and the gearbox. This will prevent dissimilar metal contact. Use anti seize grease on shaft.

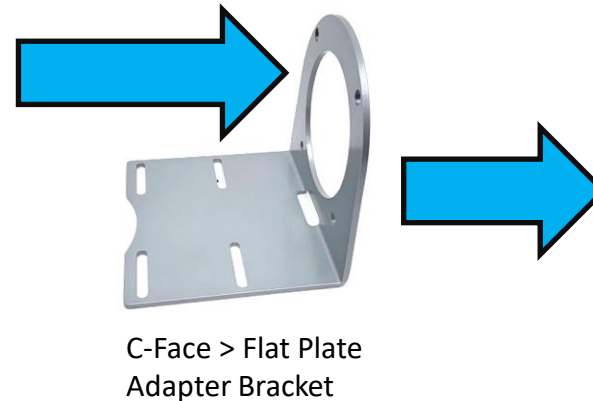
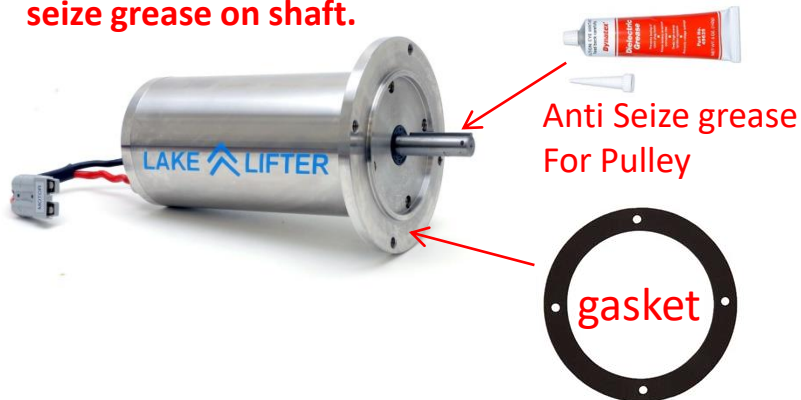

Master Control Box Overview



Control Box & Fob Switches & Buttons

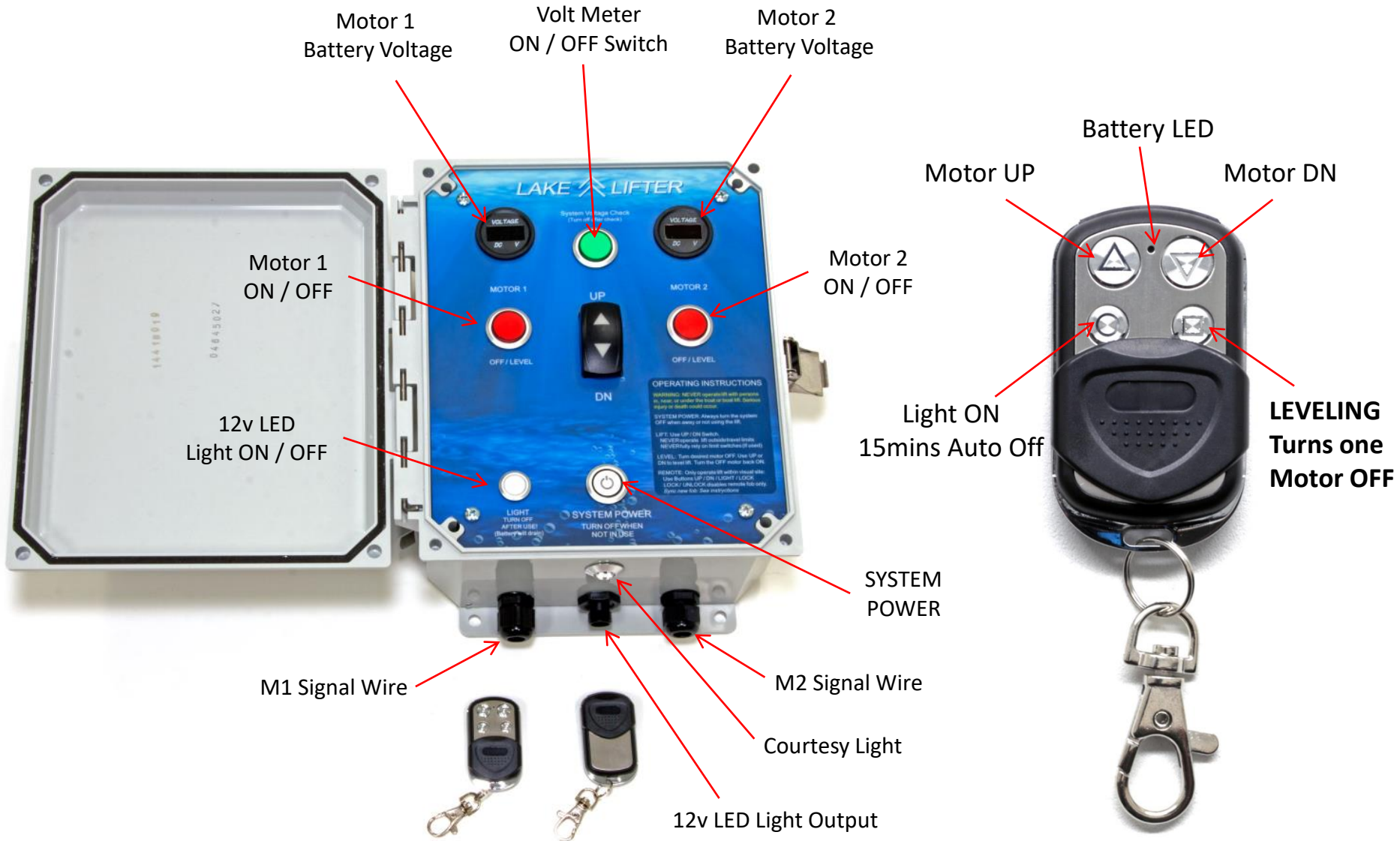

Typical System Install & Layout

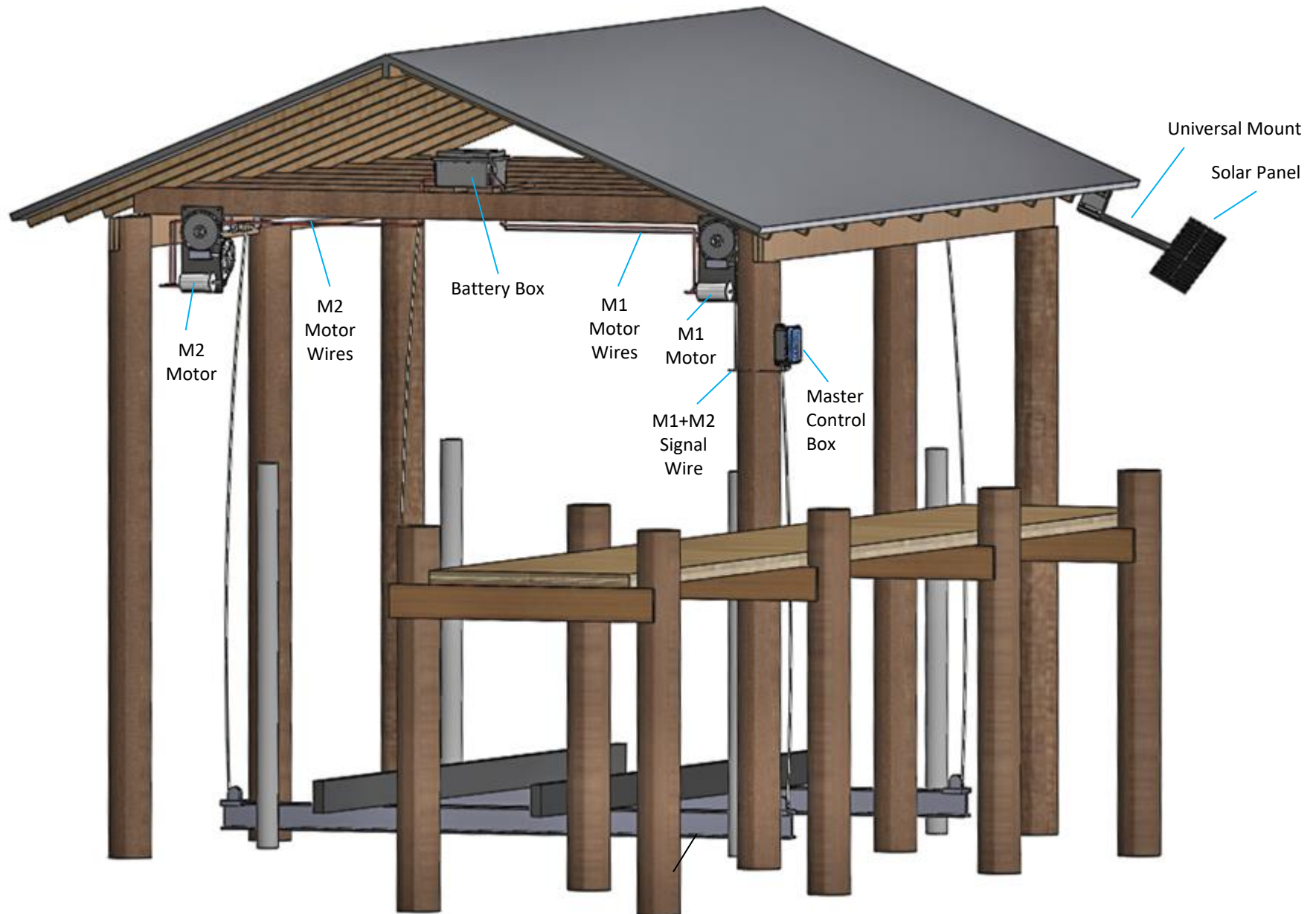

Battery Box Installation

Mount the battery box securely on the rafter beams between the motors.

NOTE: Ensure the beams are adequate to support the weight of the batteries

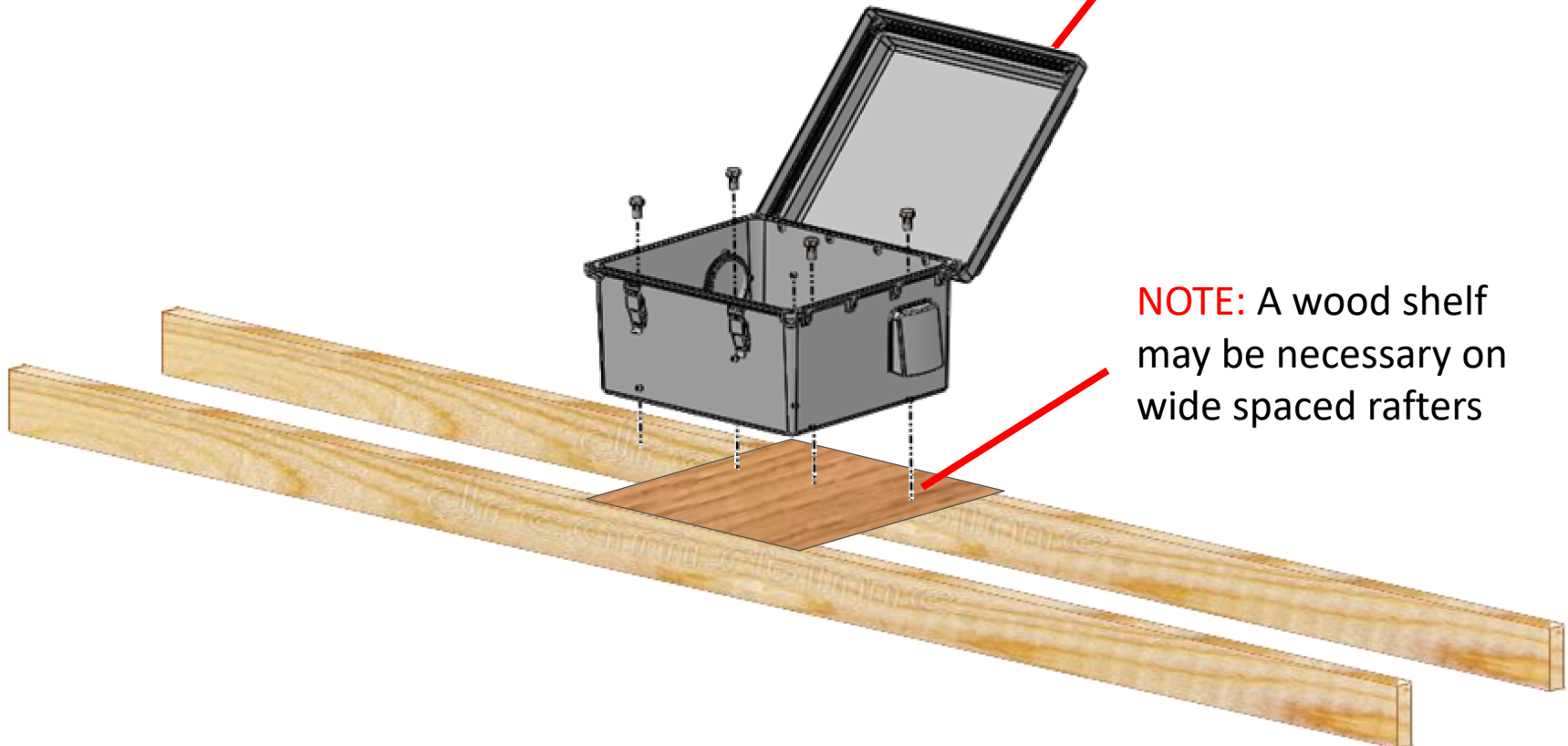
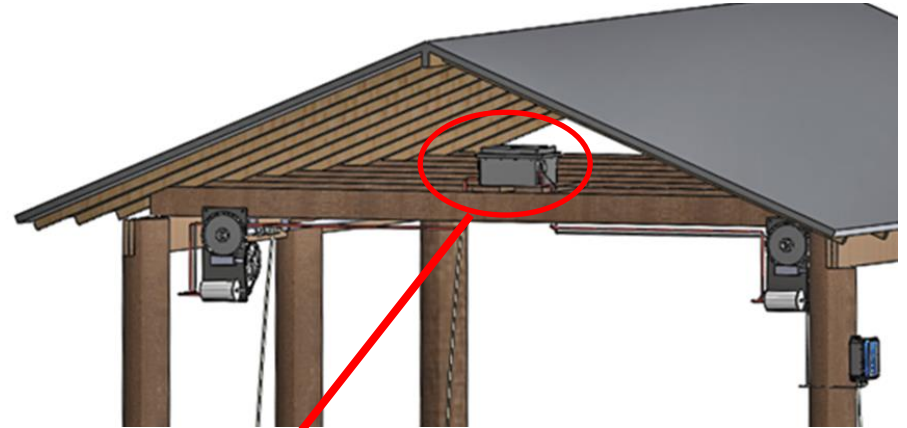

NOTE: A wood shelf may be necessary on wide spaced rafters

Motor Connection Diagram:



IMPORTANT: BATTERIES ARE THE LAST CONNECTIONS MADE!

Signal wires will be LIVE if batteries are connected and will likely result in a short connection when you are working with and routing signal wires to the master control box. Keep batteries disconnected while installing the system, running wires & connections.

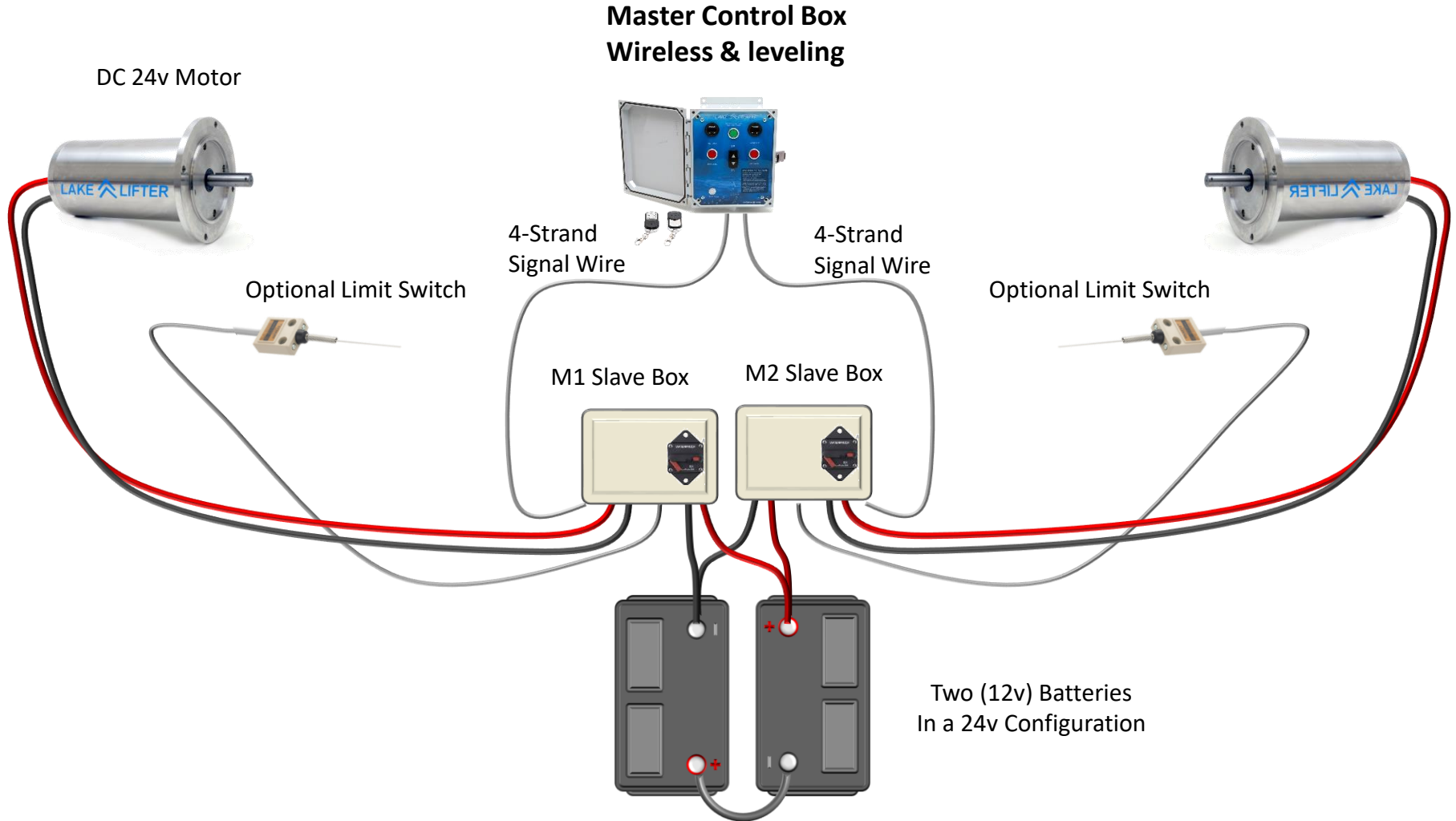

Motor & Solar Connection Diagram

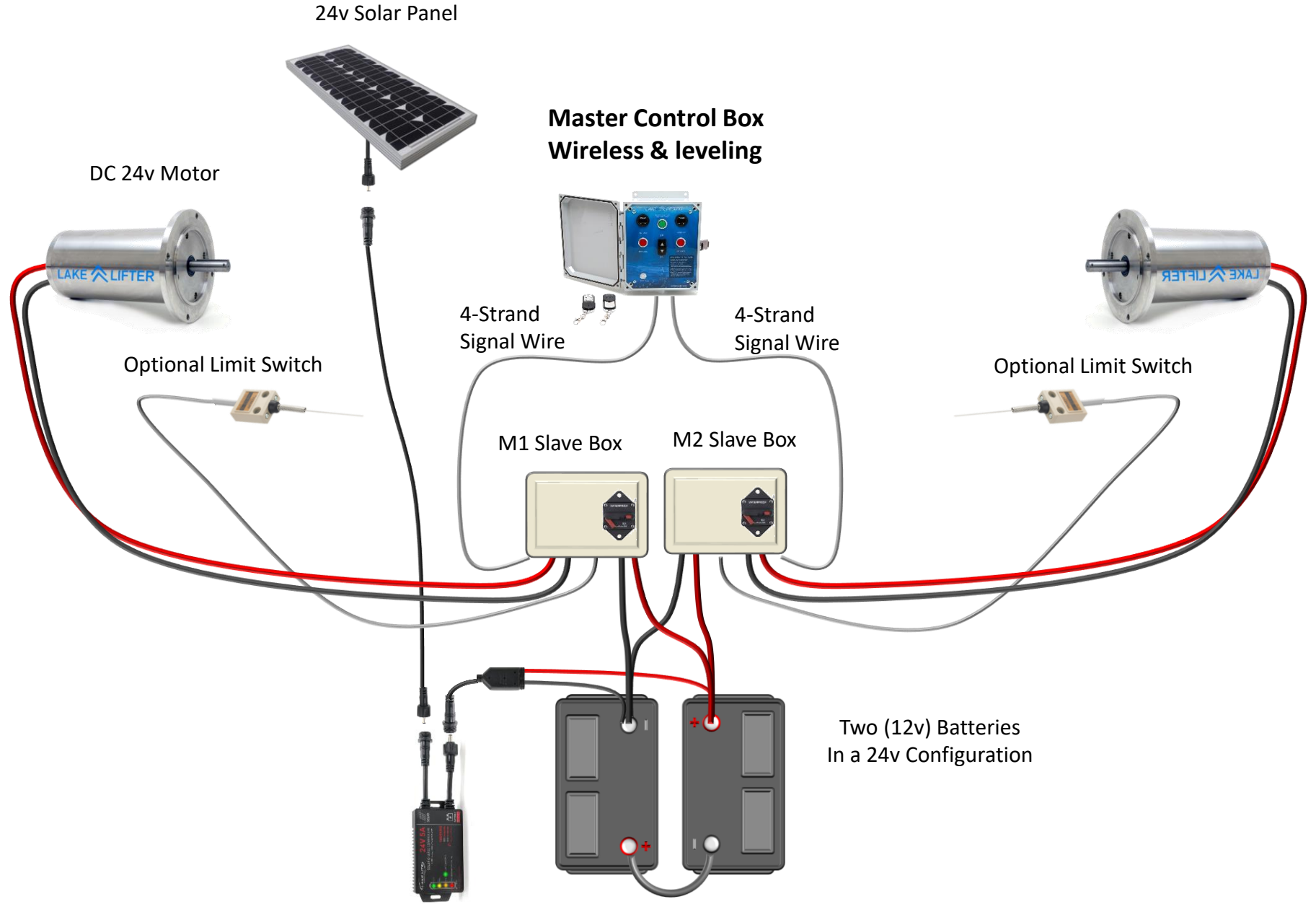

Battery Box with Slave Box & Solar Regulator

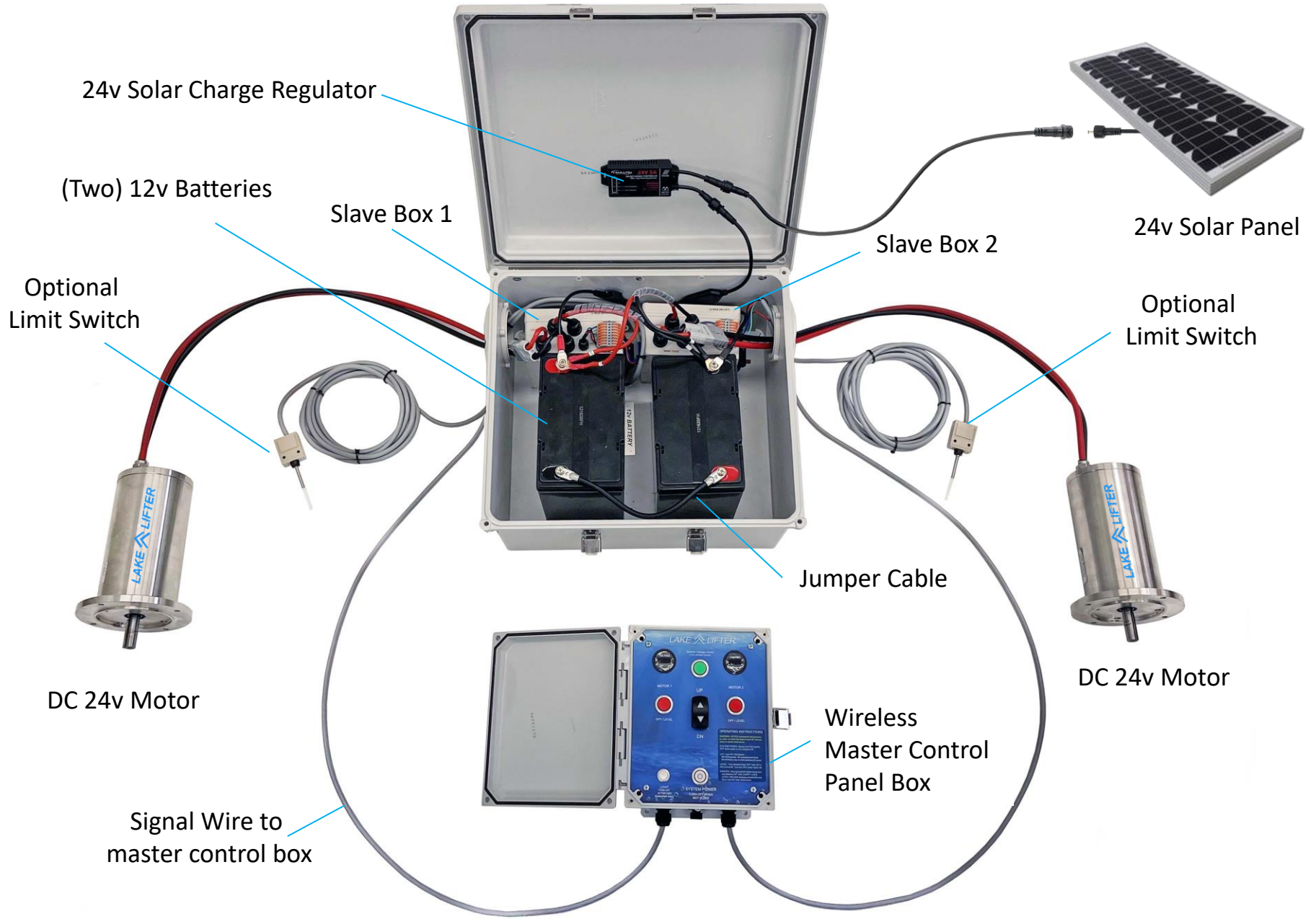

Connecting signal wires in master control box

Cut the motor signal wires to the necessary length for each motor. Insert the signal wires through the cable glands and connect them to the circuit board as shown.



MAKE SURE ALL POWER TO BOTH SETS OF BATTERIES IS DISCONNECTED WHILE ATTACHING SIGNAL WIRES!

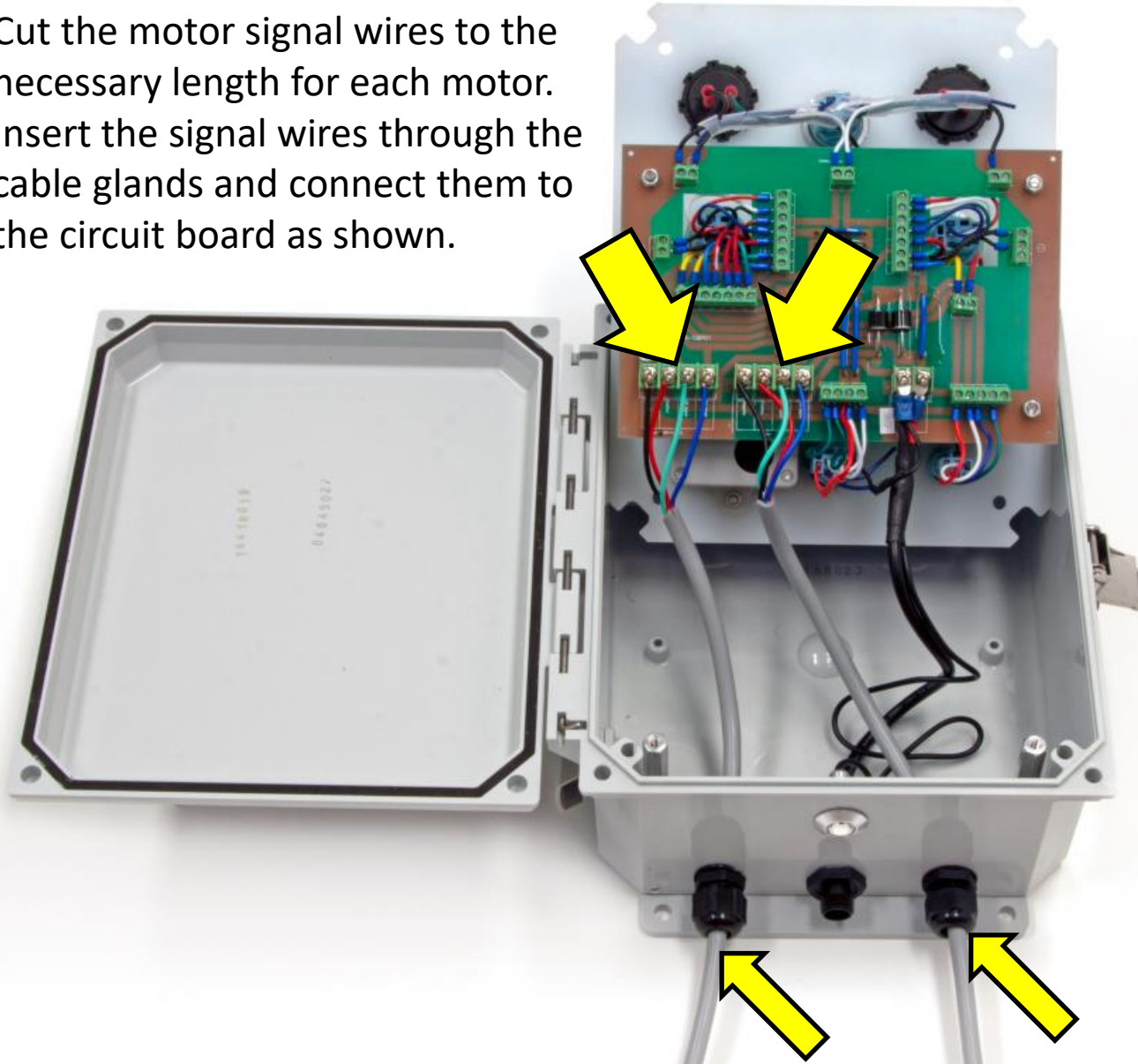

Motor Signal Wire

Motor Signal Wire

Reversing / Changing Motor Direction

Depending on the cable wrapping direction you may need to change the operating direction of the motor from the factory setting.

IMPORTANT: this may only be done at the MOTOR connector

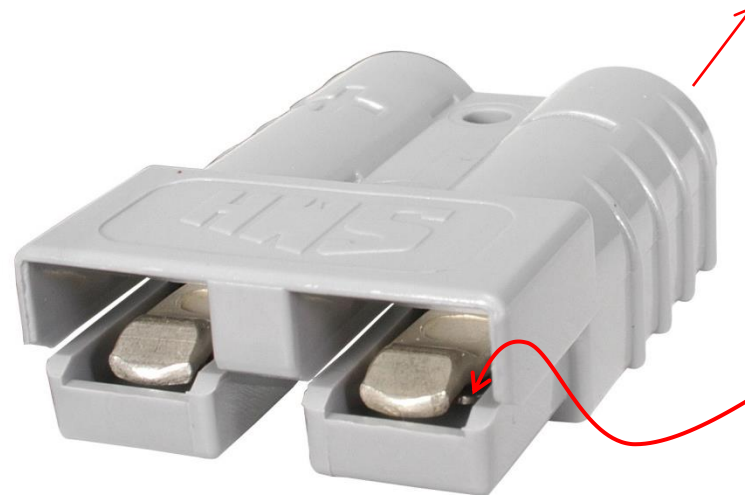

Use small thin object to push spring tab down and remove contacts from connector. Reverse Red/Back wires and re-insert into connector

Slave Box



Factory Setting
Black – Black
Red – Red

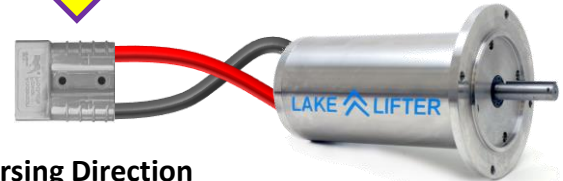

Reversing Direction
Black – Red
Red – Black

SLAVE MOTOR BOX



MAKE SURE ALL POWER TO BOTH SETS OF BATTERIES IS DISCONNECTED WHILE ATTACHING SIGNAL WIRES

Fuse Breaker



Optional Limit Switch Or Yellow Cheater Wire



Signal Wire

24v Battery Power



MOTOR CONNECTOR

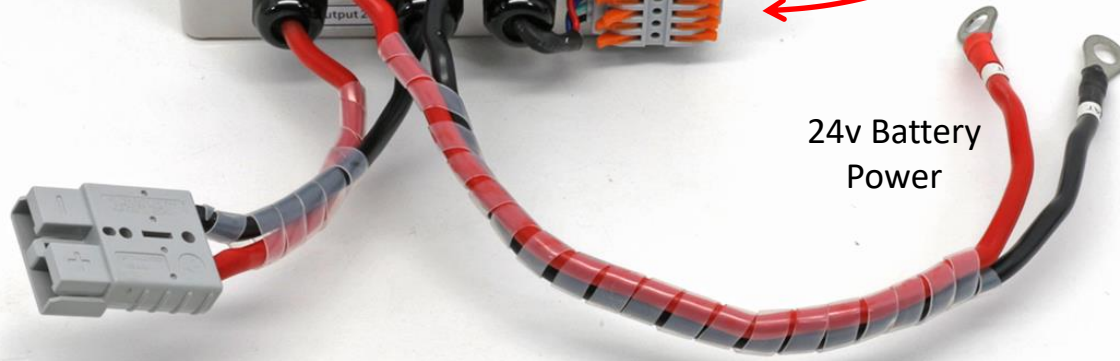

SLAVE MOTOR BOX – Excluding Limits

To bypass limits UP or DN or both simply insert a jumper wire as shown.
(Green wires in this example)

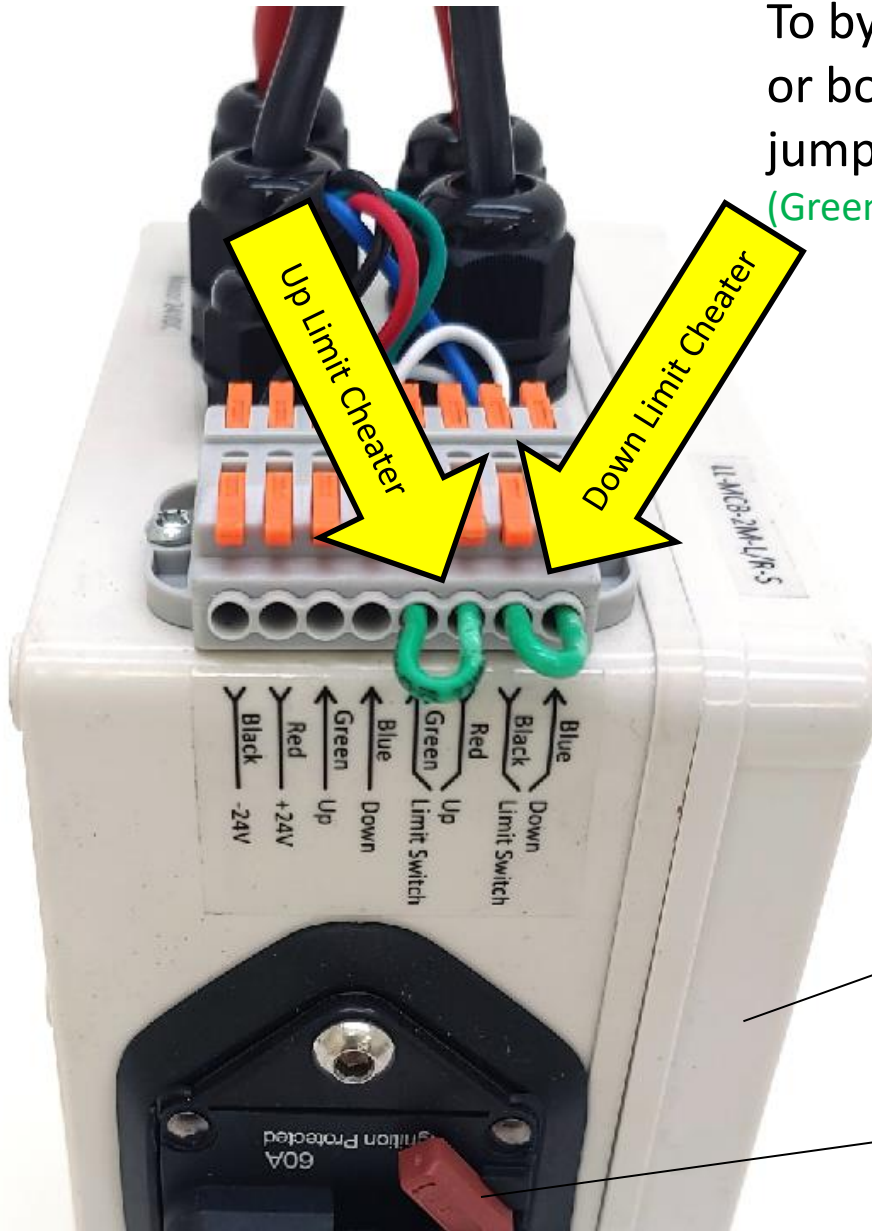

MAKE SURE ALL POWER TO BOTH SETS OF BATTERIES IS DISCONNECTED WHILE ATTACHING SIGNAL WIRES

Slave Motor Box

Push & disconnect Fuse Breaker while wiring
(Lever out = disconnected)

Limit Switch Installation: Flat Plate Gearboxes

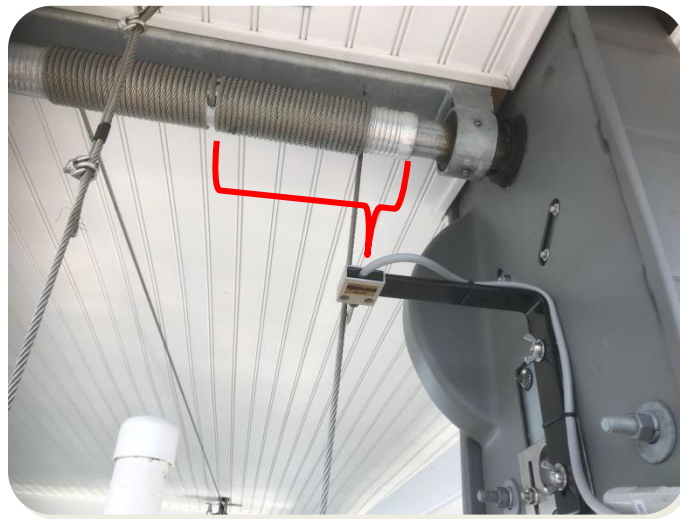

IMPORTANT: Install the limit switch in a location that will trip when the desired amount of cable has been spooled.

NOTE: Every boat lift configuration is different and it is the responsibility of the user to determine the best installation method and placement.



UPDATE: DO NOT install the limit switch where it will be tripped by the boat lift carriage. Continual non-stop movement of the carriage via wind will eventually wear out the limit switch. For longevity we recommend installing the limit switch where the cable is spooled.

IMPORTANT: NEVER rely on the limit switch. The limit switch is a last resort safety device. Operator should always pay close attention when operating the boat lift.



Spring Limit Switch



WALK UNDER BEAMS STYLE LIFT

On this style lift the user walks UNDER the I-Beams to enter/exit the boat. The carriage of the boat is not lifted anywhere near the height of the I-Beams. For this reason many users may prefer to use the limit switch for the DN direction to stop the cable from slacking when the carriage is at the lowest point or worse, unraveling and winding UP in the wrong direction. With purchase of additional limit switches you may use one for both UP & DN limits.

WALK OVER BEAMS STYLE LIFT

On this style lift the user walks OVER the I-Beams to enter/exit the boat. The carriage of the boat is often lifted very near under the I-Beams. For this reason many users may prefer to use the limit switch for the UP direction to stop the carriage from hitting the I-Beams. With purchase of additional limit switches you may use one for both UP & DN limits.

Limit Switch Installation: I-Beam Lifts

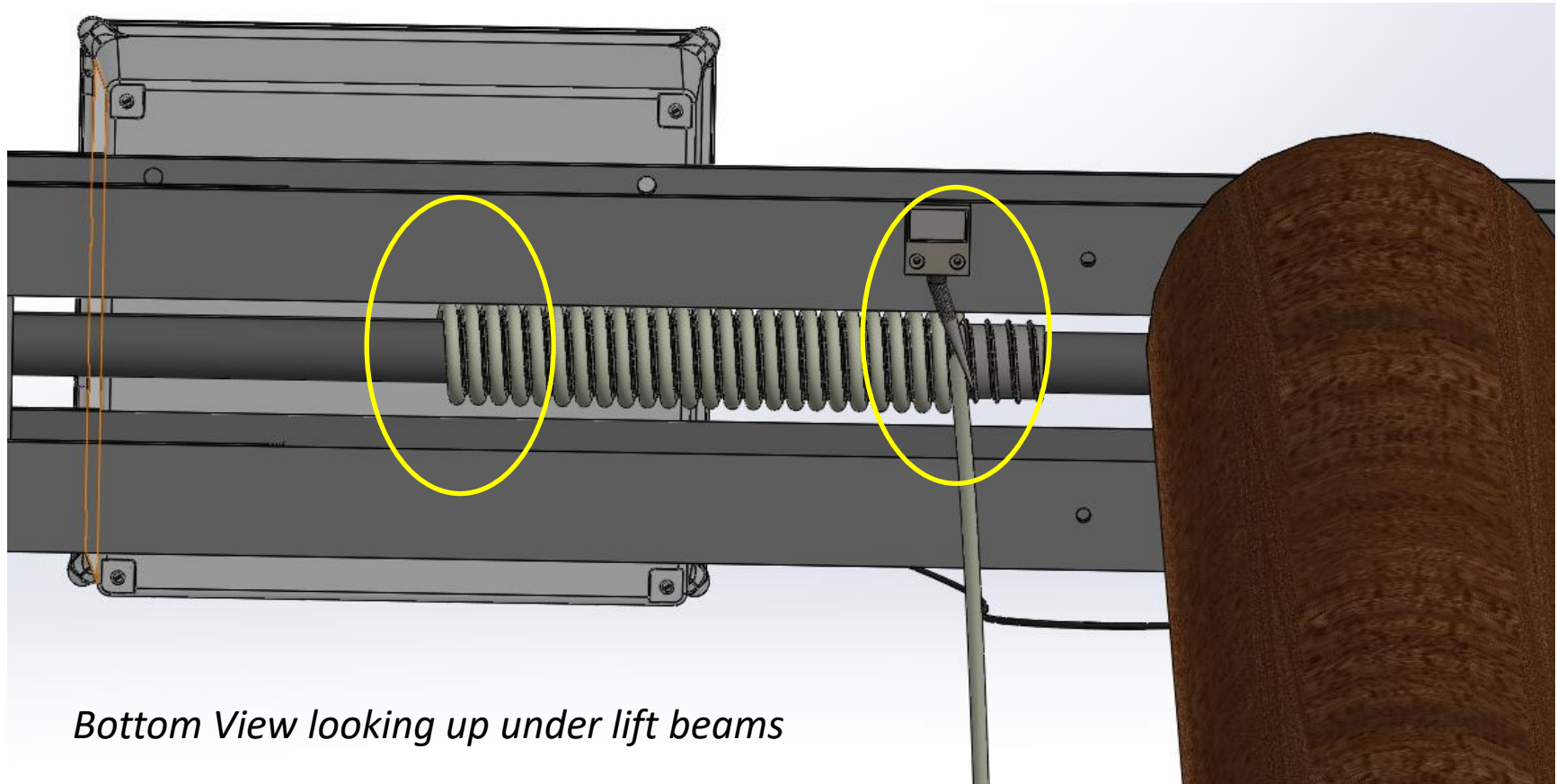

Bottom View looking up under lift beams

IMPORTANT: Install the limit switch in a location that will trip when the desired amount of cable has been spooled. Depending on the lift construction style (Walk over beams) or (Walk under beams) you may want to use the limit switch as an UP LIMIT or a DN LIMIT.

NOTE: Every boat lift configuration is different. User is responsible to determine the best installation and placement.

IMPORTANT: NEVER rely on the limit switch. The limit switch is a last resort safety device. Operator should always pay close attention when operating the boat lift.

Rotary limit switches provide the benefit of providing both an UP + DN limit. The Lake Lifter system can utilize rotary limit switches however, there are a few important factors to consider.

1. You will need **(TWO)** rotary limit switches (one for each side/motor).
1. You will need to purchase the rotary limit switches from the boat lift mfg. there are several different styles & mounting brackets that will fit your specific boat lift or boat lift brand.
1. Please ensure your boat lift supplier/mfg knows that you will need (TWO) rotary limit switches and that one will be installed on each side.
2. The rotary limit switches will need re-wired, replacing the standard AC-3strand wire with our DC-4strand wire. – see instructions.



Example
Various
Rotary
Limit
switches



KALS



KCLS



OR

KELS



E-Drive Golden gearbox (**KCLS**)



E-Drive AMS gearbox (**KELS**)

KFLS

KFLS

See if it has an extra long bolt check for clearance here Read instructions on the page 1 for installation

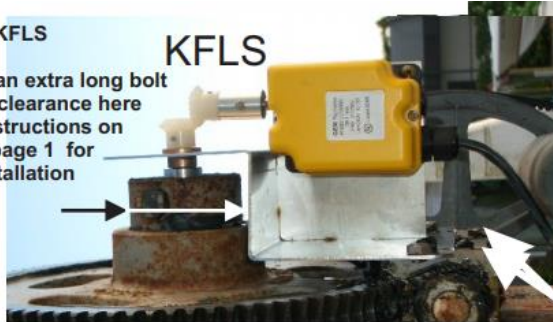

KFLS
BH-USA
AMS
ACE

Install a KFLS limit switch when the bolt on the flat plate is horizontal.

Bolts for installing KFLS



Flat-Plate Gearbox (**KFLS**)

TOOLS: Phillips Screwdriver, Small Regular Screwdriver, for KCLS units you might need a drill and 1/4 metal drill bit.

You may need to drill a hole in the drive pipe and attach the bolt that came with the limit switch, make sure bolt clears beams.

Note: bolt past the bearing.



KRLS

fits most open end pipes



Drive Pipe Model (**KRLS**)

Rotary limit switches provide the benefit of having both an UP + DN limit. To make the rotary limit switch work with the DC-powered Lake Lifter system you will remove the 3-strand wire and replace it with the provided 4-strand wire. This will allow both micro switches to work independently. (2-wires for the UP switch) & (2-wires for the DN switch).

IMPORTANT: For *DUAL* motorboat lifts you will need (Two) rotary limit switches:



Open the rotary limit switch

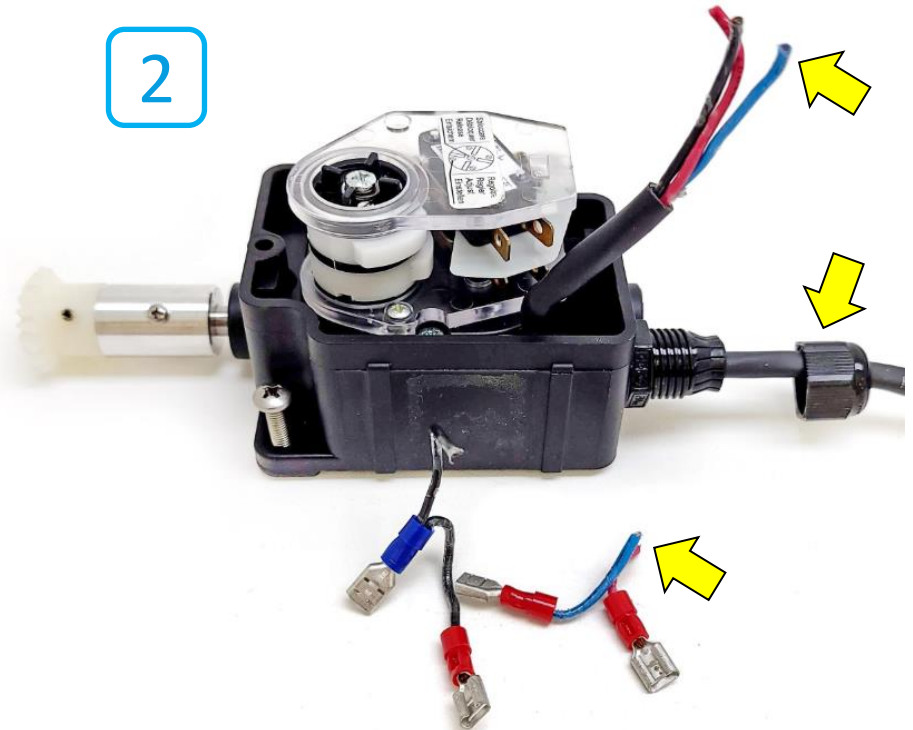

Remove the spade connectors from the micro switches. Cut the spade connectors off. Loosen the cable gland nut and pull the old wire out

3

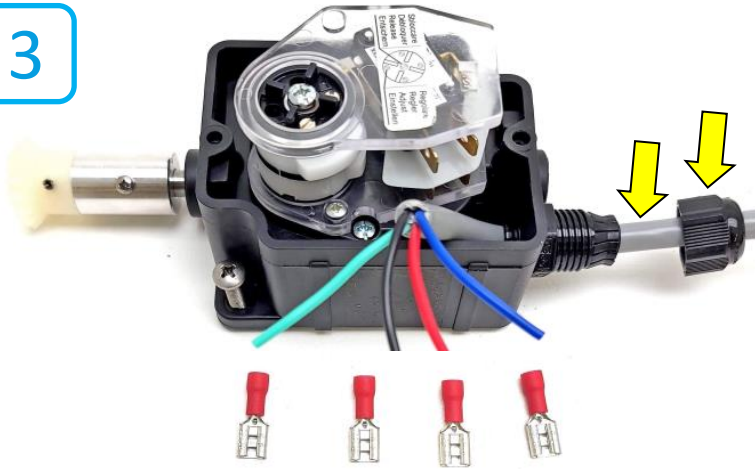

Feed the NEW 4-strand wire into the rotary switch

4

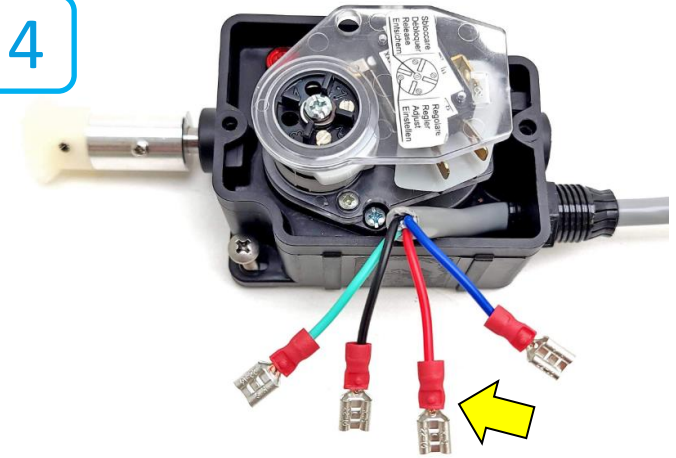

Strip the wires and attach the new spade terminals

5

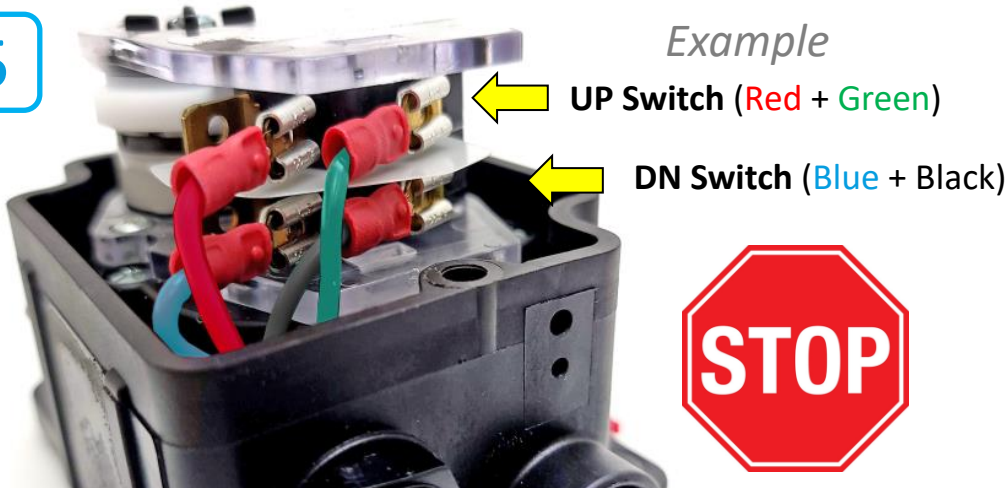

Example

UP Switch (Red + Green)

DN Switch (Blue + Black)

STOP

6



Reassemble the limit switch and tighten the cable gland

NOTE: Take photo so you remember which wire colors go to the UP & DN switches!

7

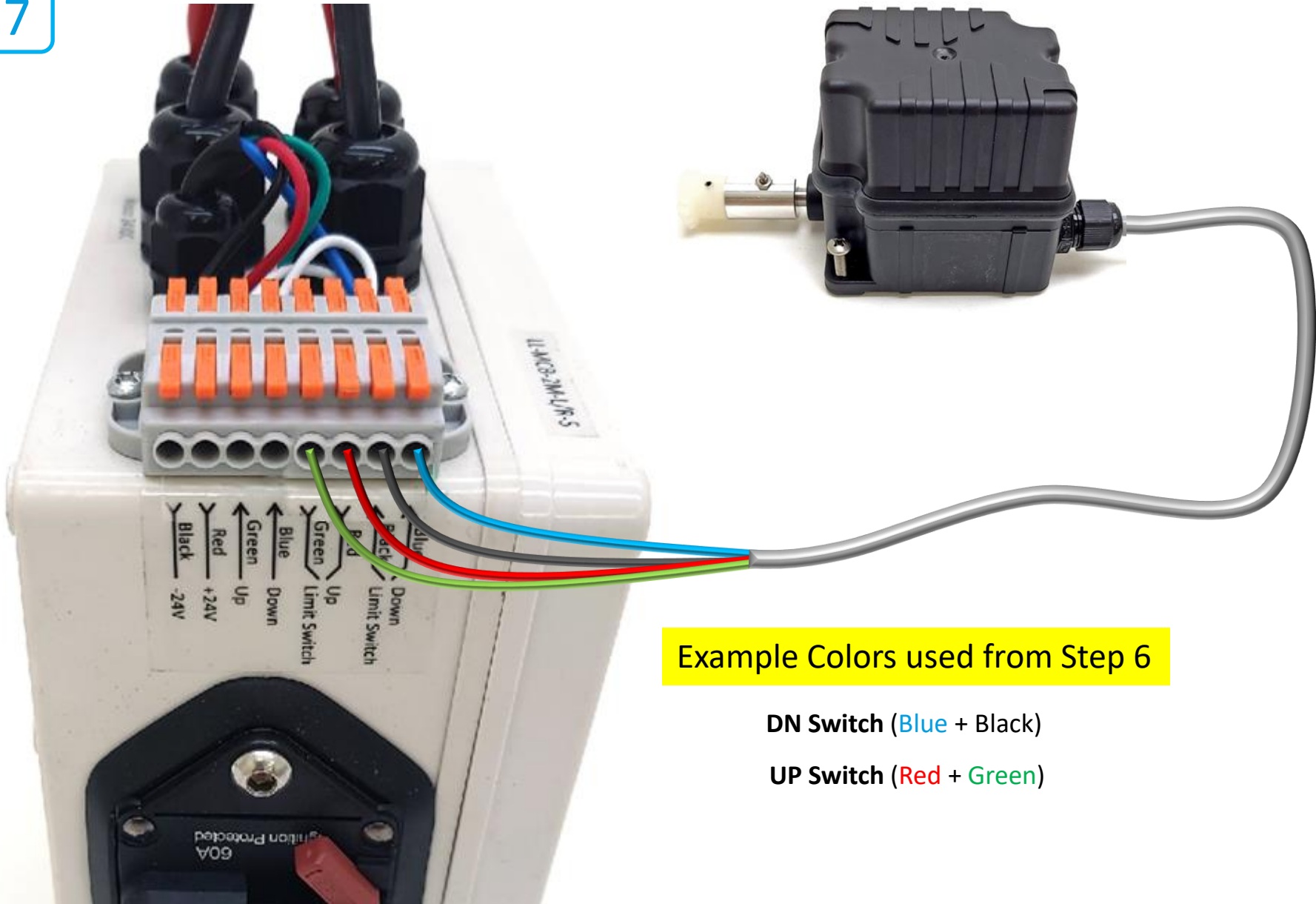

LAKE LITE – SOLAR PANEL MOUNTING KIT

Models: LL-SPMA-HD-XX 12" / 36" / 48" / 72"

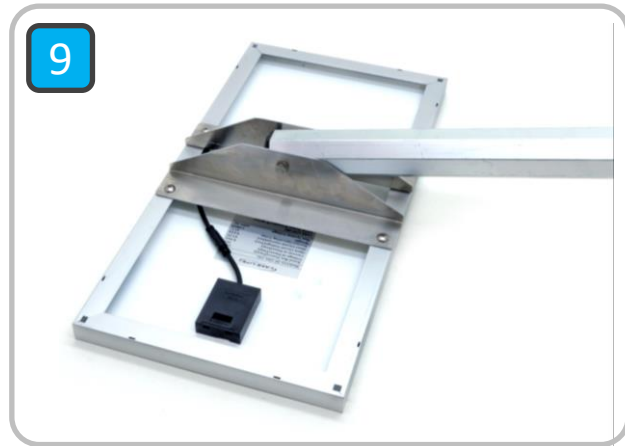
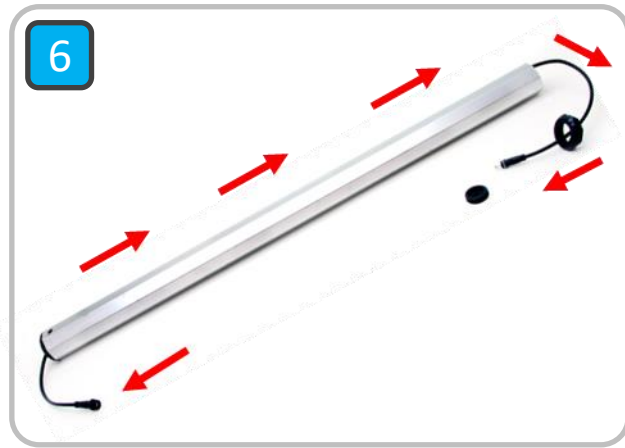
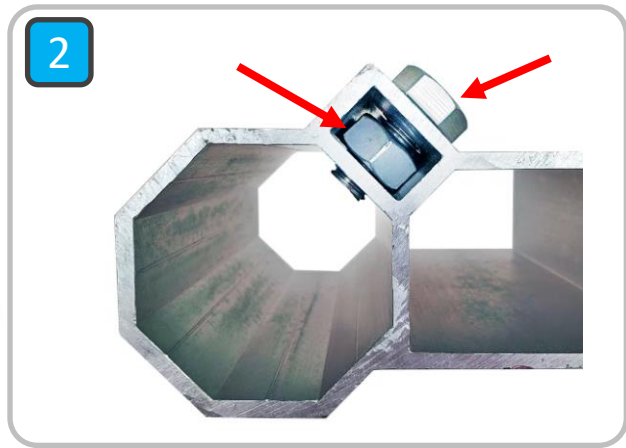
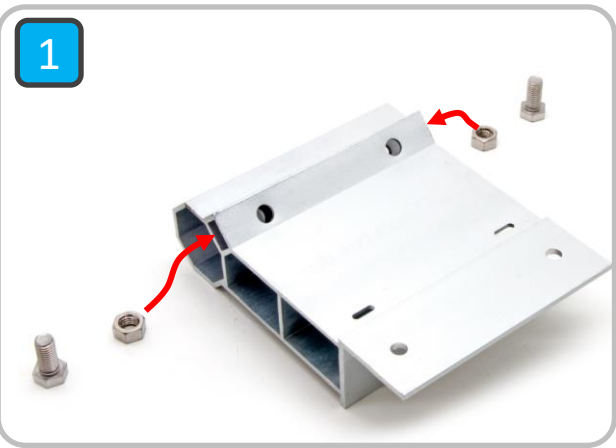

LAKE LITE – SOLAR PANEL MOUNTING KIT

Models: LL-SPMA-HD-XX 12" / 36" / 48" / 72"

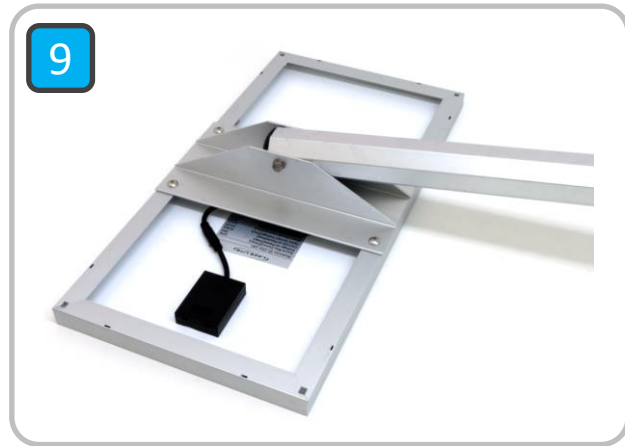
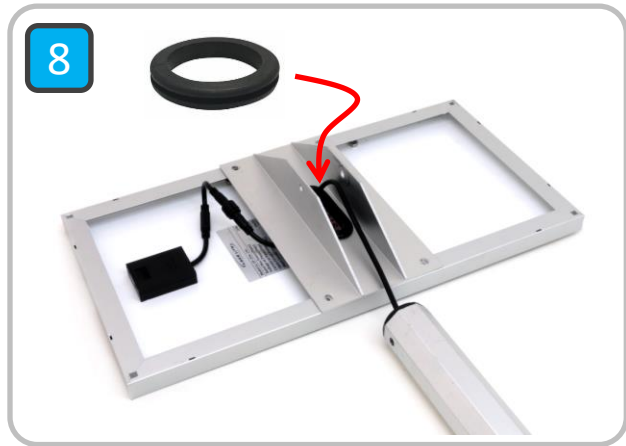
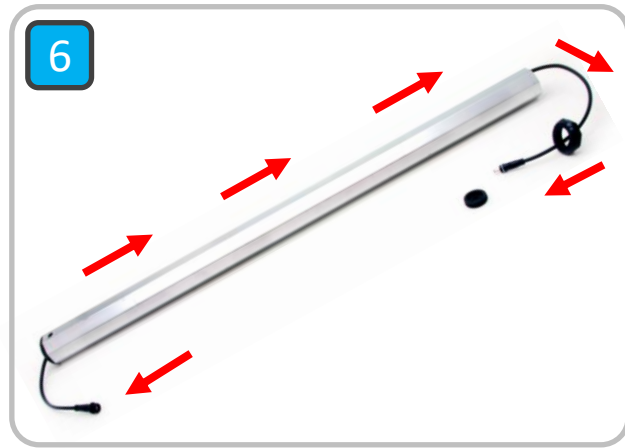
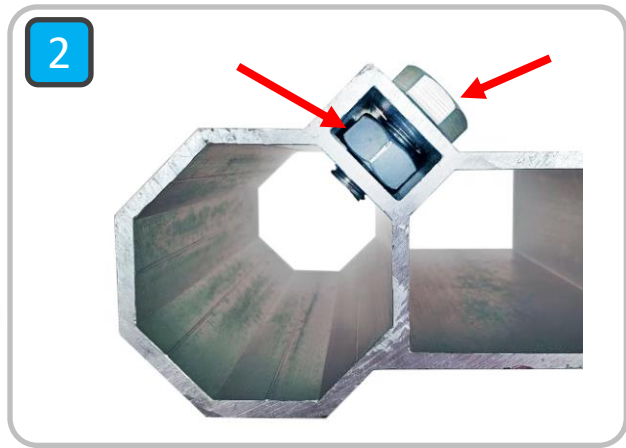
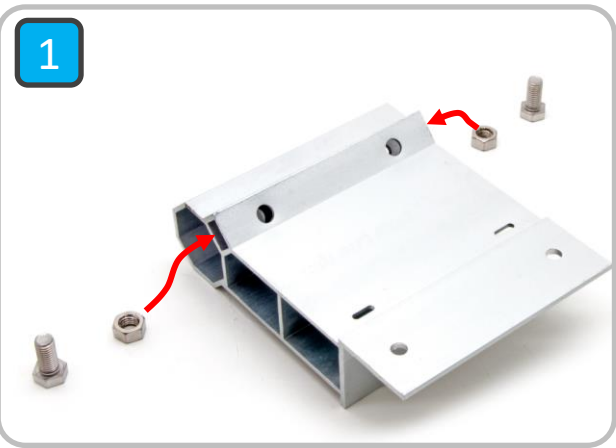

LAKE LITE – SOLAR PANEL MOUNTING KIT

Models: LL-SPMA-HD-XX 12" / 36" / 48" / 72"

10



11

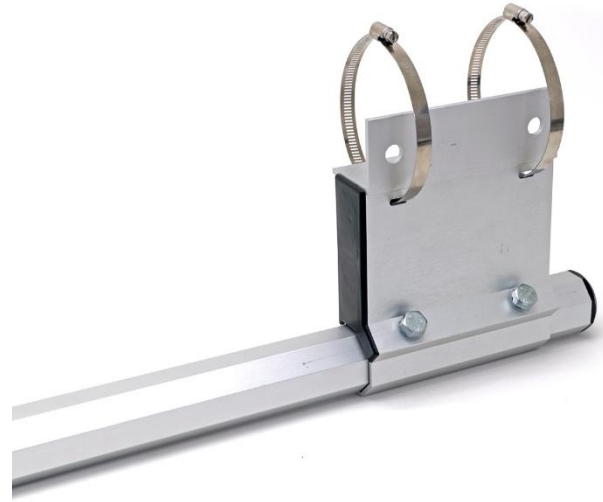

12

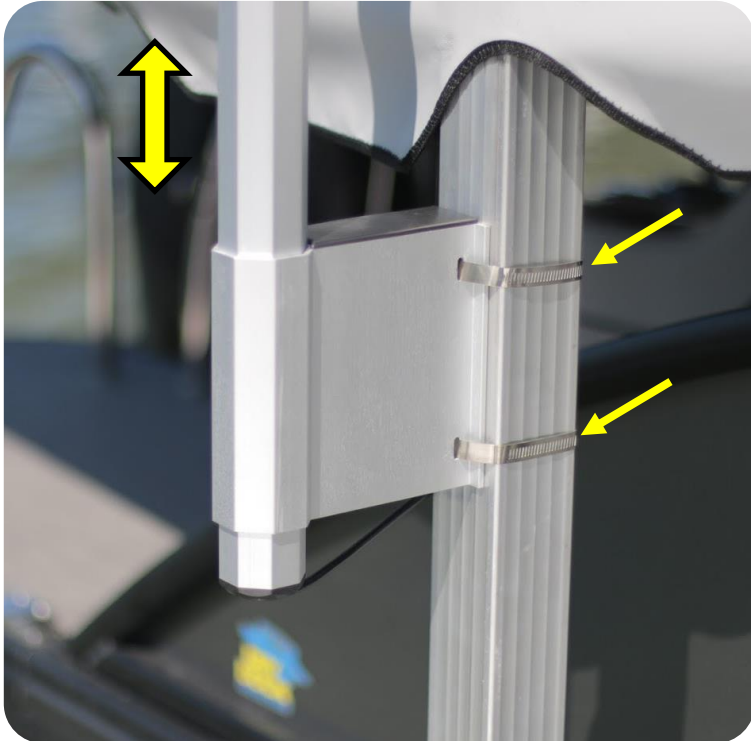

13

